

Description

The FDN86246 is the high cell density trenched N-ch MOSFETs, which provides excellent R_{DS(ON)} and efficiency for most of the small power switching and load switch applications.

The FDN86246 meet the RoHS and Green Product requirement with full function reliability approved.

- Green Device Available
- Super Low Gate Charge
- Excellent C_{dv/dt} effect decline
- Advanced high cell density Trench technology

Product Summary

V _{DS}	150	V
R _{DS(ON),max}	280	mΩ
I _D	1.8	A

SOT23 Pin Configuration

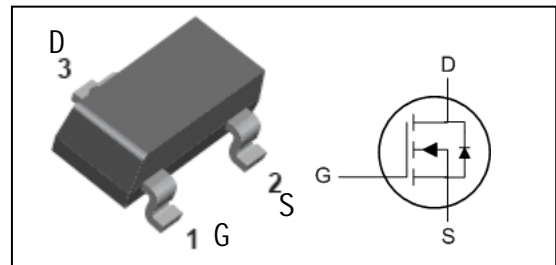

Absolute Maximum Ratings

Symbol	Parameter	Rating	Units
V _{DS}	Drain-Source Voltage	150	V
V _{GS}	Gate-Source Voltage	±20	V
I _D @T _A =25°C	Continuous Drain Current, V _{GS} @ 10V ¹	1.8	A
I _D @T _A =70°C	Continuous Drain Current, V _{GS} @ 10V ¹	1.4	A
I _{DM}	Pulsed Drain Current ²	7.2	A
P _D @T _A =25°C	Total Power Dissipation ³	1.3	W
T _{STG}	Storage Temperature Range	-55 to 150	°C
T _J	Operating Junction Temperature Range	-55 to 150	°C

Thermal Data

Symbol	Parameter	Typ.	Max.	Unit
R _{θJA}	Thermal Resistance Junction-ambient ¹	---	100	°C/W
R _{θJC}	Thermal Resistance Junction-Case ¹	---	80	°C/W

Electrical Characteristics (T_J=25 °C, unless otherwise noted)

Symbol	Parameter	Conditions	Min.	Typ.	Max.	Unit
BV _{DSS}	Drain-Source Breakdown Voltage	V _{GS} =0V, I _D =250uA	100	---	---	V
R _{DS(ON)}	Static Drain-Source On-Resistance ²	V _{GS} =10V, I _D =2A	---	240	280	mΩ
		V _{GS} =4.5V, I _D =1A	---	250	300	
V _{GS(th)}	Gate Threshold Voltage	V _{GS} =V _{DS} , I _D =250uA	1.0	2	2.5	V
I _{DSS}	Drain-Source Leakage Current	V _{DS} =150V, V _{GS} =0V, T _J =25°C	---	---	1	uA
I _{DSS}	Drain-Source Leakage Current	V _{DS} =150V, V _{GS} =0V, T _J =125°C	---	---	30	uA
I _{GSS}	Gate-Source Leakage Current	V _{GS} =±20V, V _{DS} =0V	---	---	±100	nA
Q _g	Total Gate Charge (10V)	V _{DS} =75V, V _{GS} =10V, I _D =2A	---	18	---	nC
Q _{gs}	Gate-Source Charge		---	4.6	---	
Q _{gd}	Gate-Drain Charge		---	5.7	---	
T _{d(on)}	Turn-On Delay Time	V _{DD} =75V, V _{GS} =10V, R _G =6Ω I _D =2A	---	13	---	ns
T _r	Rise Time		---	19	---	
T _{d(off)}	Turn-Off Delay Time		---	26	---	
T _f	Fall Time		---	9	---	
C _{iss}	Input Capacitance	V _{DS} =75V, V _{GS} =0V, f=1MHz	---	840	---	pF
C _{oss}	Output Capacitance		---	119	---	
C _{rss}	Reverse Transfer Capacitance		---	25	---	

Diode Characteristics

Symbol	Parameter	Conditions	Min.	Typ.	Max.	Unit
I _S	Continuous Source Current ^{1,4}	V _G =V _D =0V, Force Current	---	---	1.8	A
V _{SD}	Diode Forward Voltage ²	V _{GS} =0V, I _S =1A, T _J =25°C	---	---	1.2	V

Note :

- 1.The data tested by surface mounted on a 1 inch²FR-4 board with 2OZ copper.
- 2.The data tested by pulsed , pulse width ≤ 300us , duty cycle ≤ 2%
- 3.The power dissipation is limited by 150°C junction temperature
- 4.The data is theoretically the same as I_D and I_{DM} , in real applications , should be limited by total power dissipation.

Typical Characteristics

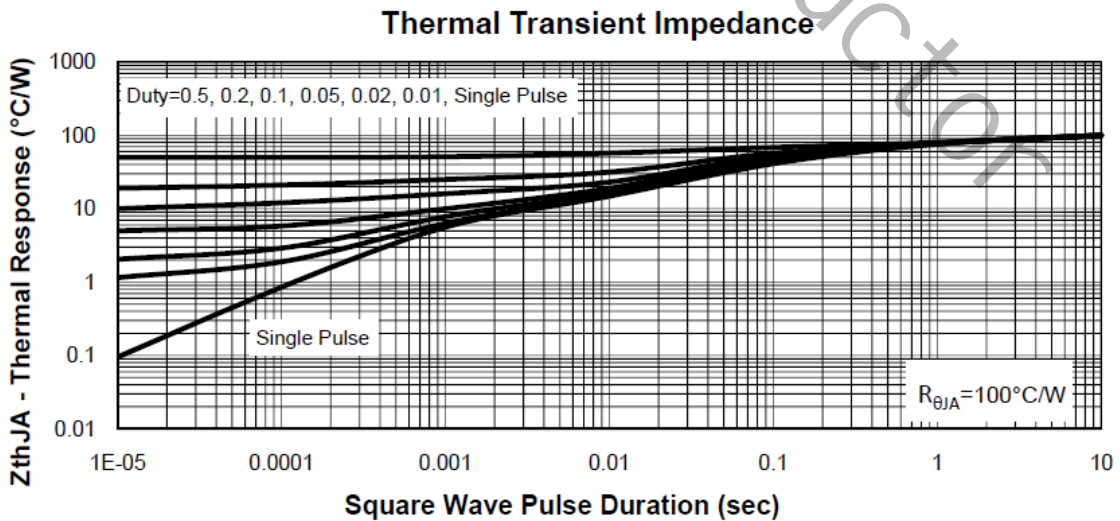
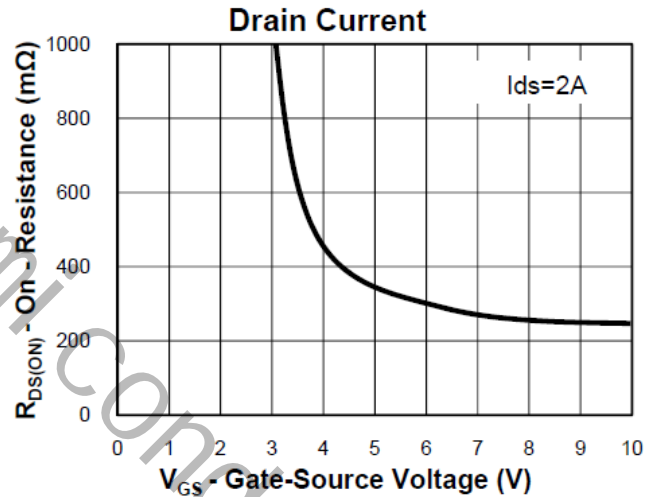
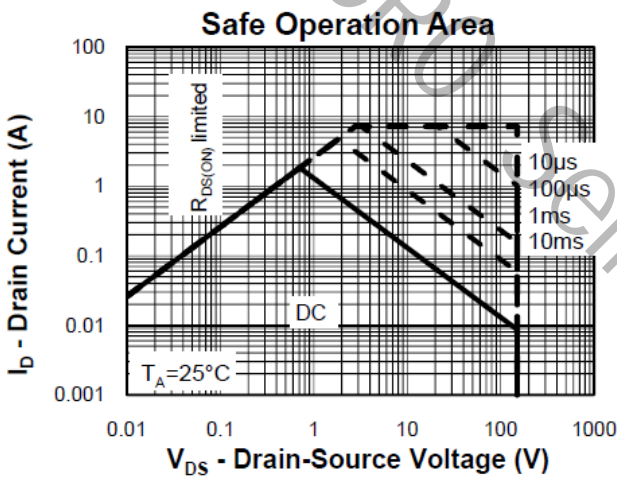
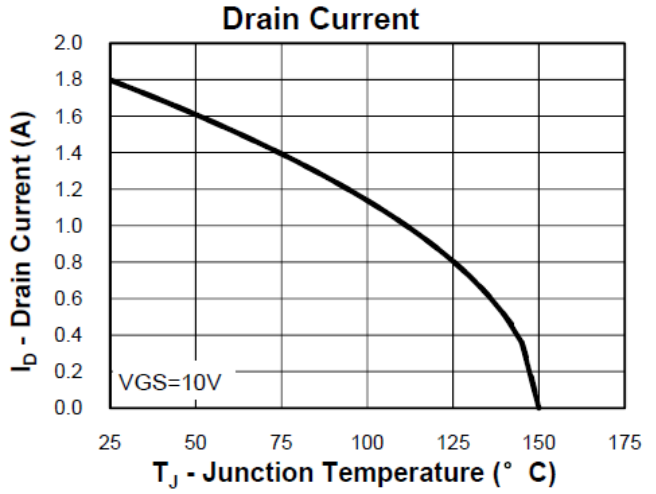
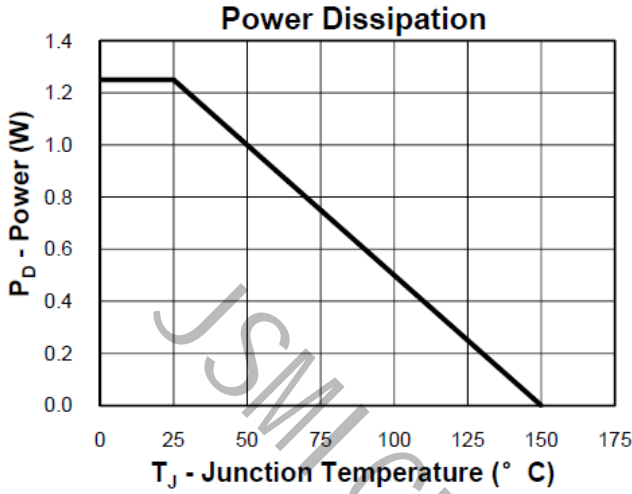

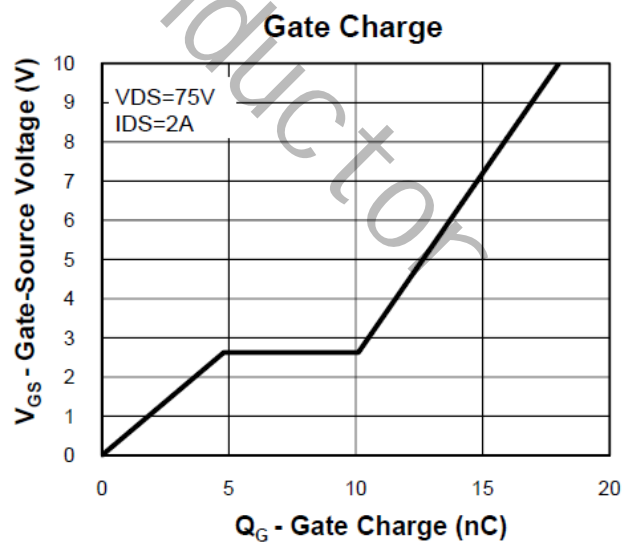
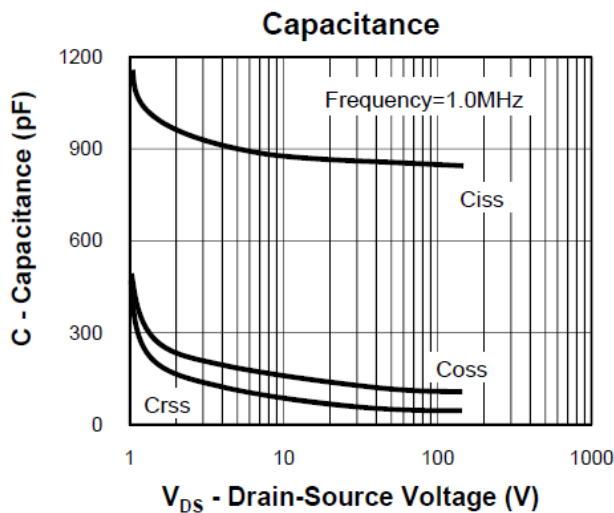
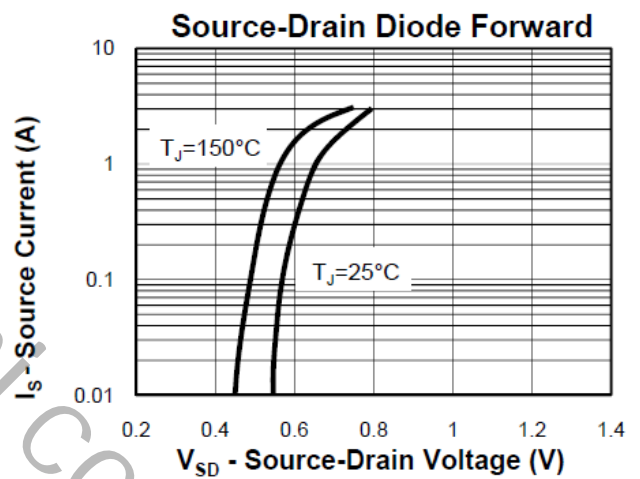
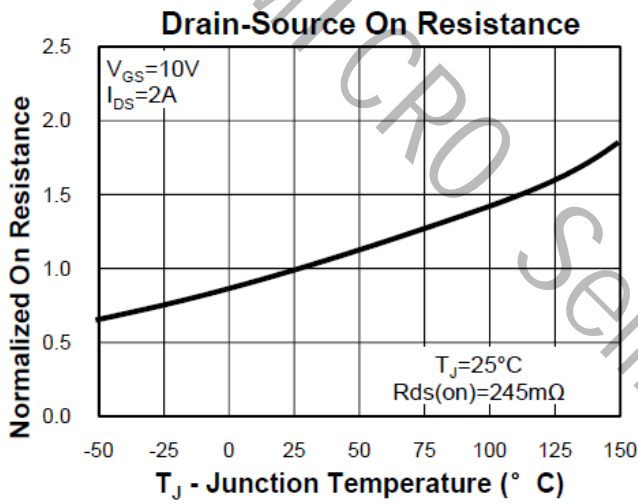
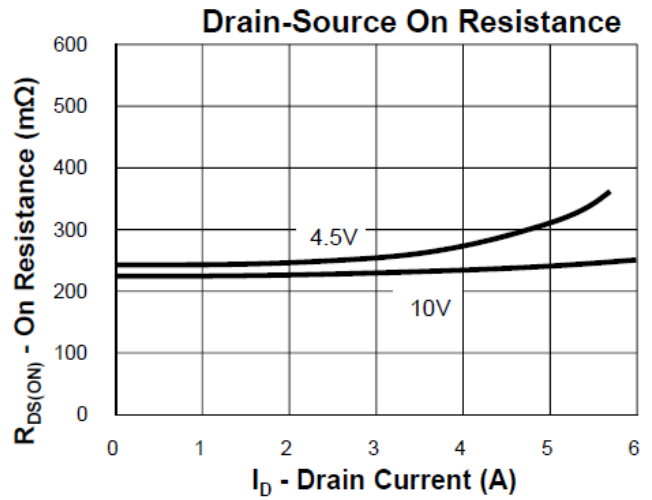
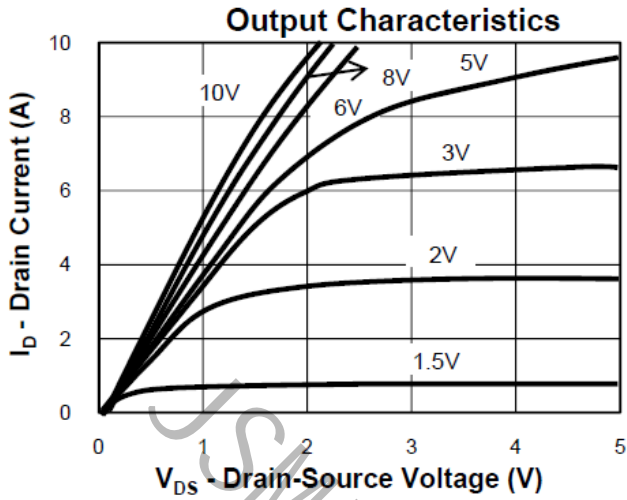

Ordering Information

Part Number	Package code	Packaging
FDN86246	SOT-23	3000/Tape&Reel

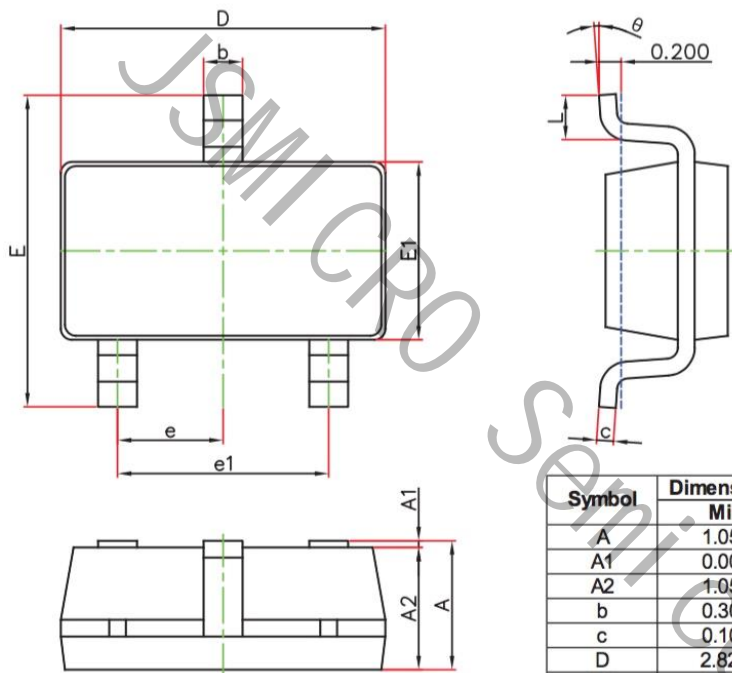

Symbol	Dimensions In Millimeters		Dimensions In Inches	
	Min.	Max.	Min.	Max.
A	1.050	1.250	0.041	0.049
A1	0.000	0.100	0.000	0.004
A2	1.050	1.150	0.041	0.045
b	0.300	0.500	0.012	0.020
c	0.100	0.200	0.004	0.008
D	2.820	3.020	0.111	0.119
E1	1.500	1.700	0.059	0.067
E	2.650	2.950	0.104	0.116
e	0.950(BSC)		0.037(BSC)	
e1	1.800	2.000	0.071	0.079
L	0.300	0.600	0.012	0.024
θ	0°	8°	0°	8°